

GUIDE FOR INSTALLATION, USE AND MAINTENANCE



DEH





Dear Customer

Thanks for your attention to the product UTEK , designed and manufactured to ensure the real values to the User :
Quality, Safety and Savings on working.

INDEX

GENERAL	pag.3
MAINTENANCE REGULATIONS	pag.3
INSTALLATION CONDITIONS	pag.3
REMAINING RISKS	pag.3
MACHINE SIGNALS - prohibition signals - danger and information signals - identification signals	pag.3
GOODS RECEPTION	pag.3
HANDLING	pag.3
STORAGE	pag.3
EXTENDED DOWNTIME	pag.3
START	pag.3
DISASSEMBLY AND ASSEMBLY	pag.3
DISPOSAL	pag.3
ENVIRONMENTAL PROTECTION	pag.4
INSTALLATION OF THE UNIT	pag.5
BRACKETS POSITIONING	pag.6
AERAULIC CONNECTIONS	pag.6
HYDRAULIC CONNECTIONS	pag.7
WIRING DIAGRAMS	pag.7
POSITIONING OF CONNECTIONS	pag.8
TERMINAL BOARD	pag.8
ELECTRICAL CONNECTIONS	pag.9
REMOTE PANEL CONNECTION	pag.9
REMOTE PANEL	pag.10
ALARMS TABLE	pag.20
TABLE OF GENERAL FAULTS	pag.20



SAFETY STANDARDS AND "CE" MARKING

Our technicians are steadily engaged in research and development of more and more efficient products in compliance with the safety "standards" in force. The standards and suggestions contained herein reflect the safety standards in force and, therefore, are mainly based on the compliance of said general regulations. Consequently, we would suggest all people exposed to risks to comply the accident prevention regulations in force in their respective countries. UTEK s.r.l. are exempted from any responsibility attributable to damage caused to persons and things resulting from the non-compliance with the safety standards and any product modifications. The CE marking and the relevant declaration of conformity prove the conformity to the applicable community regulations. Products which are not provided with the CE marking must be certified by the purchaser who shall have to certify the conformity of the whole plant.

Units are as prescribed by:

- Machinery directive 2006/42/EC
- Low Voltage Directive EEC 2014/35/EU
- Electromagnetic compatibility directive 2014/30/EU

GENERAL

Safety protection devices may not be removed if this is not absolutely necessary. In this case, suitable measures to point out the possible danger shall be immediately taken. The restoration of said protection devices on the product shall take place as soon as the reasons for the temporary removal cease. All (ordinary and extraordinary) maintenance interventions shall be carried out with disconnected machine and electrical and pneumatic supply. In order to avoid the risk of possible accidental starts, provide the electric panels, the central units and the switchboards with warning signals with the following reading "caution: control disconnected for maintenance works". Before connecting the electrical supply cable to the terminal board make sure that the line voltage is in compliance with the voltage stated on the machine plate. Replace the product labels if, with the passing of time, they should become illegible.

MAINTENANCE REGULATIONS

The personnel maintenance is subject to the prevention devices must keep to the accident prevention regulations in force and to the following instructions:

- wear suitable accident prevention clothes
- when the noise exceeds the admissible levels, use protection headsets
- machine must be provided with an interlock which prevents of the machine by non-authorized persons

INSTALLATION CONDITIONS

Installation allowed inside the buildings or outdoor, with temperature between 0° to $+45^{\circ}$ C

To avoid:

- areas near sources of heat source, steam, flammable and/or explosives gases, dusty areas

To consider:

- consider an area where the air flow and noise of the unit don't disturb the neighbors;
- minimum space required for the maintenance (as defined below);
- the floor or wall must be suitable to the weight of the unit and don't cause vibrations;
- a position that does not block passageways or entrances;
- the unit must be canalized
- measures to protect the fan vents with special protection to prevent contact with moving mechanical parts; The protection degree is IP20. In case of outdoor installation, place the unit in a place sheltered from the weather.

REMAINING RISKS

The risks of the products have been analyzed according to the Machine Directive. (all. I of Directive 2006/42/CE) The present handbook contains information for all persons in charge and has the purpose to avoid possible damages to persons and/or things attributable to remaining risks.

REMAINING RISKS

The risks of the products have been analyzed according to the Machine Directive. (all. I of Directive 2006/42/CE) The present manual contains information for all persons in charge and has the purpose to avoid possible damages to persons and/or things attributable to remaining risks.

MACHINE SIGNALS

The machine can be provided with several signalling pictograms which may not be removed. Said signals can be subdivided into:

- PROHIBITION SIGNALS

Do not repair or adjust during motion



- DANGER AND INFORMATION SIGNALS

. Attention to the presence of electric current



. Automatic start Danger



. Attention to the instruction manual



. Grounding the machine



- IDENTIFICATION SIGNALS

Serial number plate: it states the product data and the manufacturer address.



REMARK: other signals can be added to the product according to the analysis carried out on the remaining risk.

GOODS RECEPTION

Each product is carefully checked before shipping. On goods reception, it is necessary to make sure that products have not suffered any damages during transport. If goods have been delivered damaged, send a complaint to the forwarder. The forwarder agent is responsible for any transport damages. Products are wrapped and tied or packed in self-supporting cardboard boxes which are fastened to pallets.

HANDLING

Goods must be displaced by the correct means of transport with suitable carrying capacity. For pallet lifting use forklifts. According to the standard 89/391/CEE and following standards, manual lifting is admissible up to a max. weight of 20 kg under shoulders level, but over floor level.

STORAGE

Store the unit in a sheltered spot, without excessive moisture and not subject to sudden changes of temperature in order to avoid the formation of condensation inside the unit.

EXTENDED DOWNTIME

In case of extended downtime with the unit connected to the ventilation system, close the suction/ injection and periodically check the absence of humidity inside the machine. In case of condensation, dry it immediately.

STARTING

Before starting it is opportune to carry out some checks: (follow the safety instructions in section DISASSEMBLY AND ASSEMBLY):

- Make sure there is no condensation inside the unit, and if necessary, wipe it dry before attempting to operate the unit;
- Check the filters status;
- Make sure the product does not contain any foreign matters and that all components are fastened in their seats;



DISASSEMBLY AND ASSEMBLY

Before starting any operation, make sure the product is excluded from any electrical connection and the impeller is switched off. Disassembly and assembly are extraordinary maintenance operations and must be carried out by qualified personnel.

DISPOSAL

Directive 2012/19/EU of the European Parliament and of the Council of 4 July 2012 on waste electrical and electronic equipment (WEEE).



The WEEE symbol on the product or on its packaging indicates that the product must not be disposed of with normal household waste. Instead, such marked waste equipment must be disposed of by arranging to return to a designated collection point for the recycling of waste electrical and electronic equipment. By separating and recycling this waste equipment at the time of disposal will help to conserve natural resources and ensure that the equipment is recycled in a manner that protects human health and the environment. The final user will provide to deliver the product no longer in use in municipal electrical and electronic waste collection, or return it to the retailer as follows:

- distributors provide for the collection, at retail shops with sales areas relating to EEE of at least 400 m², or in their immediate proximity of very small WEEE (no external dimension more than 25 cm) free of charge to end-users and with no obligation to buy EEE of an equivalent type;
- for products with external dimension more than 25 cm, distributors are responsible for ensuring that such waste can be returned to the distributor at least free of charge on a one-to-one basis as long as the equipment is of equivalent type and has fulfilled the same functions as the supplied equipment. The Member States shall lay down the rules on penalties applicable to infringements of the national provisions adopted pursuant to this Directive and shall take all measures necessary to ensure that they are implemented. The penalties provided for must be effective, proportionate and dissuasive.

ENVIRONMENTAL PROTECTION - Troubleshooting

The law on the regulation of the use of substances that damage the ozone in the atmosphere state that it is forbidden to release coolant gases into the atmosphere, obliging the users to recover these gases and return them at the end of their useful life to dealers or special collection centers. The coolant used by this unit is listed among the substances that require special handling as foreseen by current laws and that must therefore comply with the above-mentioned provisions. It is therefore highly recommendable to perform all maintenance operations with maximum care in order to minimize coolant leaks.

ENSURING PROPER INSTALLATION, MAINTENANCE OR SERVICING OF THE EQUIPMENT

Installation and maintenance or servicing of equipment should be carried out by personnel and companies holding an appropriate certificate.

PREVENTING AND REPAIRING LEAKAGES

All operators of stationary refrigeration, air conditioning and heat pump applications, regardless of the amount of the quantity of refrigerant contained, must:

- prevent leakage
- repair leakages as soon as possible once they have been detected, through all measures technically feasible and not entailing disproportionate costs.

CHECKING FOR LEAKAGE

Working and temporarily out of operation applications containing 3kg or more (6kg or more in case of hermetically sealed systems labeled as such) of F-Gas refrigerant, have to be checked for leakage at regular intervals. The operator of the application is responsible for ensuring that this check is carried out by certified personnel.

RECOVERING THE REFRIGERANT

Operators must make arrangements for the proper recovery, i.e. the collection and storage, by certified personnel of F-Gas refrigerants from the cooling circuits of stationary refrigeration, air conditioning and heat pump equipment to ensure their recycling, reclamation or destruction. This activity must take place before the final disposal of the equipment and when appropriate during maintenance or servicing work.

NOTE

- This product is classified as a non-hermetically sealed unit containing fluorinated greenhouse gases governed by the Kyoto protocol, on which its operation depends.
- For the type of refrigerant contained and the relative quantity, refer to the product label.
- The maintenance, assistance and repair of the product can only be carried out by qualified personnel according to the laws in force.
- The disposal and demolition of the product can only be carried out by qualified personnel in accordance with the laws in force.
- In no case should the user try to intervene on the cooling circuit or to disassemble the product.
- In relation to the quantity of refrigerant present in the product, an annual verification of the system may be necessary, aimed at ascertaining the absence of leaks and filling in a special register where the checks and activities carried out are noted.



INSTALLATION DEH

CEILING INSTALLATION

Minimum space required for the maintenance (mm)

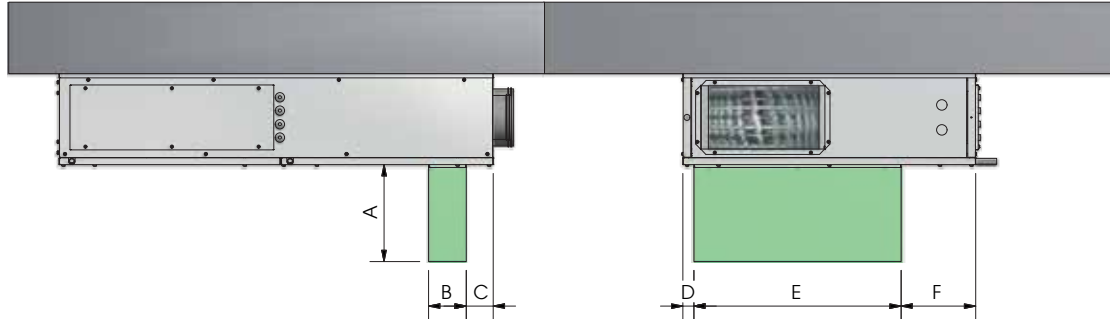

MODEL	A	B	C	D	E	F
DEH 1	270	110	76	30	580	210
DEH 2	330	110	73	30	650	275

Minimum space required for the maintenance (mm)

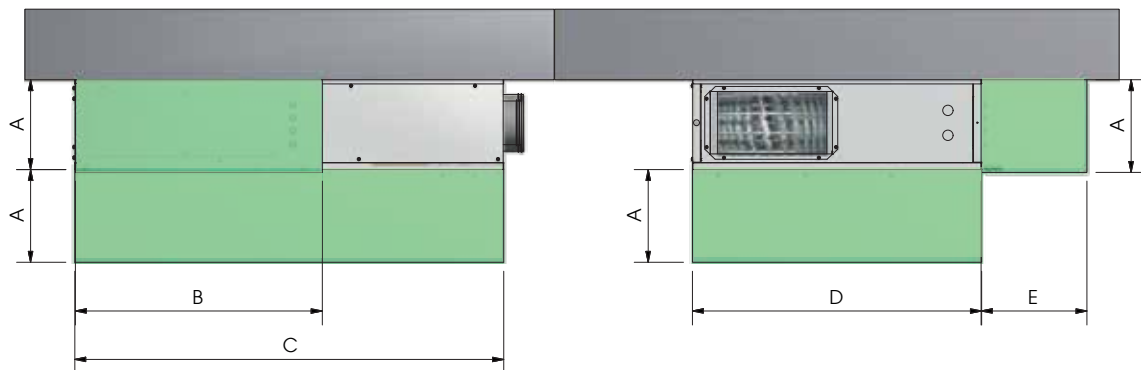

MODEL	A	B	C	D	E
DEH 1	260	700	1220	820	300
DEH 2	330	700	1220	960	300

N.B. : DEH and DEH-HYDRONIC: provide 2 siphons, the 2 condensate drains must each have their own siphon; DEH-ENTALPICO and DEH-ENTALPICO-HYDRONIC provide 1 siphon

*This operation must be performed **ONLY BY QUALIFIED STAFF***



Install the unit through appropriate means (weight from 85 kg to 103 kg) in order to avoid risks during the load handling procedures. Do not stand under the unit until it is completely attached to the ceiling. During installation you may need to work at height (over 2m H). Therefore evaluate the risks of falling, inert suspension or generic injury and take the necessary precautions



PPE: Personal Protective Equipment



BRACKETS POSITIONING



Fix the fixing brackets on the most suitable profile for the installation of the unit. Use screws or rivets to fix the brackets supplied. Then use a suitable dowel or a threaded bar for anchoring the unit to the wall.



AERULIC CONNECTIONS



The unit has circular attacks for the connection of the air ducts except the air introduced into the environment which provides a rectangular connections. We recommend the installation of at least 500mm of flexible pipe to avoid vibrations ,annoying noises due to installation

DEHUMIDIFICATION CONFIGURATION

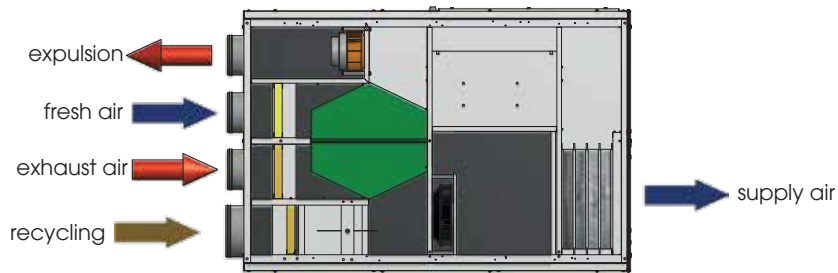

VMC CONFIGURATION

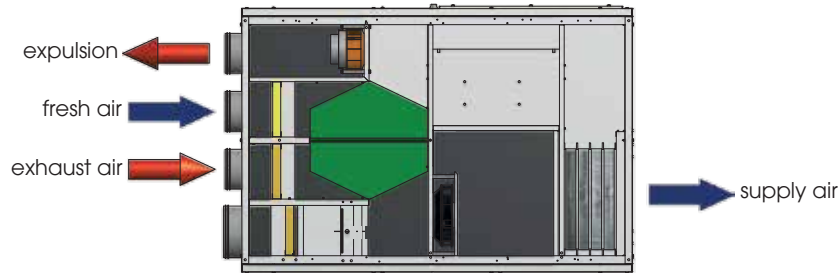

Table Diameter area connections to units

SIZE	30/15	50/20
expulsion/fresh air/exhaust air Ø (mm)	125	160
recycling Ø (mm)	160	200
fresh air (mm)	300X200	500X250



This operation must be performed **ONLY BY QUALIFIED STAFF**



CAUTION: Before performing any procedure on the unit make sure that there is no voltage



PPE: Personal Protective Equipment



HYDRAULIC CONNECTIONS



The units are equipped with hydraulic circuits that can vary depending on the different versions and applications. The connections on the unit, even in different applications and versions, are always common to all units.

- Before that the water enters in to the unit (both user side, both dissipation side), install always a thick mesh filter (max. 1 mm)
- Be sure to observe the flows shown on the plates: IN (incoming water to the unit), OUT (outgoing water from the unit)
- Make sure that the weight of the pipes doesn't go to damage the predisposed attacks
- Provide shutoff valves in the pipes flow and return pipes to the system
- All chilled water piping shall be insulated to minimize the undesirable interchange of heat and condensation.
- Before performing the filling of pipes, make sure the same does not contain extraneous materials: such as sand, stones, rust, weld spatter, slag, etc. Otherwise make a washing of the hydraulic circuit by-passing the unit.
- Absolutely avoid cavitation of the pump and the consequent presence of air in the hydraulic circuit.

Chemical and physical properties of water

chemical and physical properties are not compatible could prejudice the integrity 'of the hydraulic parts of' Geosin units. Check the water characteristics, especially in the case of direct application W with ground water on the heat exchanger.

DESCRIPTION	LIMIT VALUE	POSSIBLE CONSEQUENCES WITH VALUE OUT OF LIMIT
HARDNESS	< 10°F	Possible corrosion of stainless steel and rupture exchanger dissipation
PH VALUE	7,5/9	
OXYGEN	< 2 mg/l	
CONDUCTIVITY	< 500 uS/cm	
IRON	< 2 mg/l	
MANGANESE	< 1 mg/l	
NITRATE	< 70 mg/l	
SULPHATE	< 70 mg/l	
COMPOUNDS OF CHLORINE	<300 mg/l	
CARBON DIOXIDE RADICAL FREE	<10 mg/l	
AMMONIUM	< 20 mg/l	

ATTENTION: The water entering the coil must NOT exceed 45 ° C

WIRING



COLLECTOR CONNECTION RADIANT SYSTEM

The unit is powered by a radiant system collector circuit. Ensure that there is the required flow on the circuit.

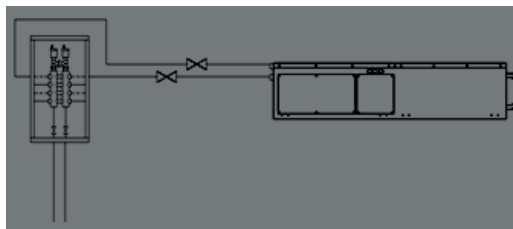

COLLECTOR CONNECTION RADIANT SYSTEM - RECOMMENDED -

The unit is supplied in parallel to the radiant system collector, having so 'guaranteed the necessary water flow for the correct operation.

N.B.The miss to flow nominal water in to the unit, blocks the unit

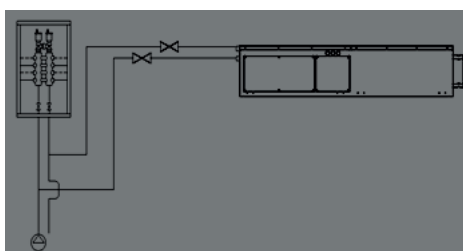



POSITIONING AND PROCEDURES OF CONNECTIONS



The hydraulic connections are positioned in the front of the unit on side of the entrances of the air inlet ducts.

Connections are a diameter 1/2" for Let compressor version, while 3/4" for the hydronic version.
Observe the IN as the unit water inlet and OUT as the water exits the unit.

TERMINAL STRIP UNIT '

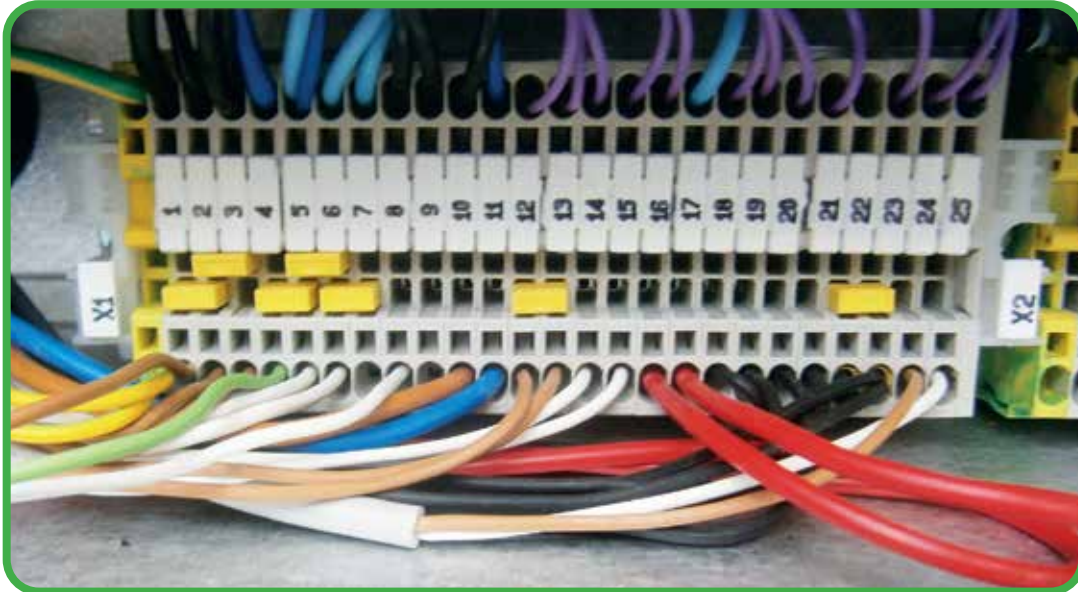

TERMINAL STRIP CONNECTIONS BY THE CUSTOMER

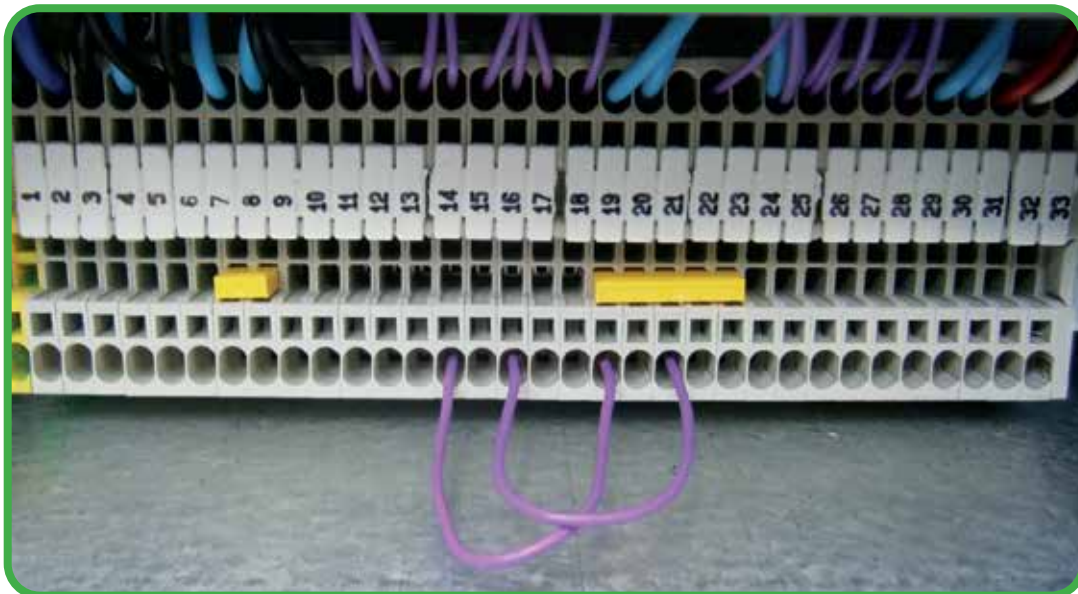

This operation must be performed ONLY BY QUALIFIED STAFF



CAUTION: Before performing any procedure on the unit make sure that there is no voltage



PPE: Personal Protective Equipment



ELECTRICAL CONNECTIONS

The unit is equipped with a series of auxiliary commands for various functions, which can be enabled or disabled depending on the needs. The functions are located in the terminal strip of x2 'units. Below are listed the individual functions in detail.

Temperature required

The temperature required contact, enable the unit in summer or winter integration operation. It is possible to connect a room thermostat that enables the function at the time of request. If you use the remote control panel to set the set of comfort, leave the jumper in the terminal strip X2.

Humidity request

The request Humidity contact, will enable the unit in the operation of summer or winter dehumidify. It is possible to connect an ambient humidistat that will enable the function at the time of request.

On-Off Remote

The on-off remote, allows you to turn on or turn off the unit with a clean electrical contact. It can be useful to turn off the entire unit in moments of inactivity avoiding energy consumption.

Change Summer-Winter remote

The summer - winter remotely, allows you to change the season and the work logic of the unit through a dry contact.

Operation Only Ventilation

Through the only opening of the contact of the fan, the unit will exclude out any type of adjustment on dehumidification and integration.

REMOTE PANEL CONNECTION



The installation must be done by trained personnel. For optimum operation, the remote panel must be fixed to a Internal wall, about 1.5 m above the floor, away from heat sources (radiators, stoves etc.) and should not be exposed to direct sunlight. Not should be installed near doors slamming may destroy the electronics.

The connection of the remote control panel is through the connection with 3-wire cable and Belden 8772 cable (3xawg20) The maximum distance between the controller and interface is mt.150. The 31-32-33 terminals are for the terminal connection (see wiring diagram).





MAINTENANCE AND CLEANING OF FILTERS



View the video about maintenance in our website www.utek-air.it



This operation must be performed **ONLY BY QUALIFIED STAFF**



CAUTION: Before performing any procedure on the unit make sure that there is no voltage



PPE: *Personal Protective Equipment*



MAINTENANCE AND CLEANING OF HEAT EXCHANGER

ATTENTION! Handle the heat exchanger carefully to avoid accidents. It is strongly recommended the use of gloves and glasses



This operation must be performed **ONLY BY QUALIFIED STAFF**



CAUTION: Before performing any procedure on the unit make sure that there is no voltage



PPE: Personal Protective Equipment



PANNELLO REMOTO

CONTROL PANEL - DESCRIPTION AND STARTING

The units control panel is a graphic keyboard with a screen resolution of 82x156mm and IP65 front protection.

The interface is structured through masks, in which there are written, graphic symbols and numbers.

The keys are located on the black bar at the bottom of the display.

In the unit's main menu is displayed:

- The status of the unit among the following:

- 1.Stand-by
- 2.Off Remote
- 3.Dehumidification
- 4.Integration
- 5.Ventilation only
- 6.Dehumidification+Integration
- 7.Antifreeze Reduced Speed
- 8.OFF From Antifreeze

-Time and date

-Temperature and humidity

- 4 symbols representing:

VENTILATION DEHUMIDIFY SUMMER INTEGRATION WINTER INTEGRATION



There are 8 Keys; each action corresponds to an action according to the following logic:

- 1- ON / OFF button (T1): Allows the unit to be switched on / off, the button must be pressed for 2 seconds
- 2- PROBES button (T2): Allows the display of the connected probes
- 3- ALLARM button (T3): Allows the view of the alarms in progress
- 4- SET button (T4): Allows the access to the menu SET
- 5- USER button (T5): Allows the access to the machine status display menu
- 6- SERVICE button (T6): Allows the access to the SERVICE menu
- 7-SUMMER button (T7):Change the operating mode from winter to summer (if the season change mode is set to 1- Change from Keypad and the machine is in standby or remote off);the button must be pressed for 2 seconds
- 8- WINTER button (T8):Change the operating mode from summer to winter (if the season change mode is set to 1- Change from Keypad and the machine is in standby or remote off);the button must be pressed for 2 seconds

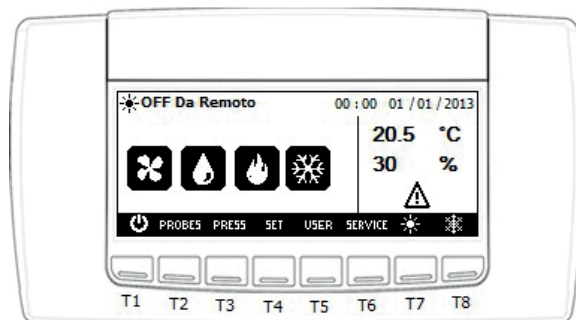

Meaning of the main display keys:

Here are the icons of the keys present in the main mask

	PROBES It allows the display of the value of the probes configured in the instrument		SET Button for displaying the current mode set point
	Button for selecting summer mode		ALARM Key for displaying alarms in progress
	Key for selecting winter mode		SERVICE Key to access the menu Service
	Button STD-BY		



IGNITION AND SHUTDOWN OF UNIT

-The unit can be enabled and disabled in two different ways.

The first through a clean contact connected to a device for switching the unit on / off remotely: like a switch or a timer.

The second through the button  in the main mask of the display. If the external on / off contact is closed it will be possible to enable and disable the operation of the unit via the display if the contact is open it will not be possible to enable the display unit.

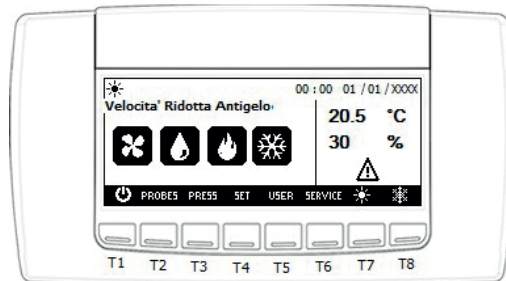

Mainstage

CONTROL PANEL - PROBE DISPLAY

Pressing the button  on the main screen displays the values of all the probes connected to the unit. Press Exit to return to the main screen.

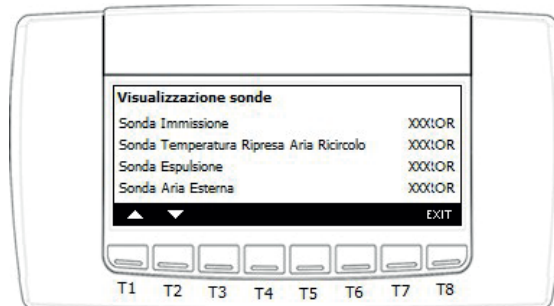

Display of probe mask

MENU SET

By pressing the set key it is possible to access the setting menu of the machine operating set.

In this menu the following parameters are set:

Temperature and humidity comfort sets;

in summer mode only those related to the summer operation will be visible, while in winter mode only those related to winter operation will be visible.

It is also possible to set the fan operating speed, choosing between 1 (low speed), 2 (average speed) and 3 (high speed).

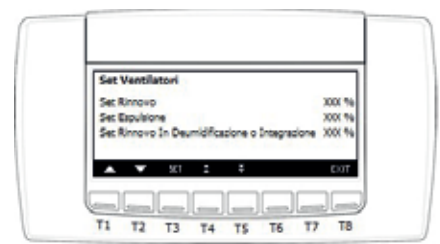
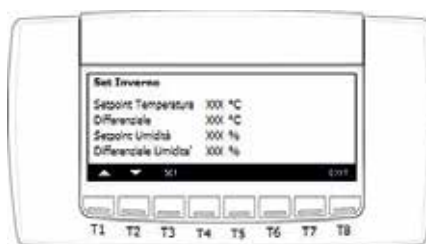
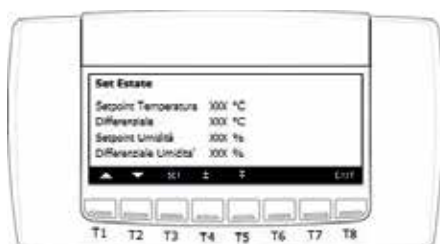

Viewing the display menus and information



MENU USER

By pressing the USER key, you can access the display menu of the unit status. In this menu the following states are displayed:

- STATE COMPRESSOR
- 3-WAY VALVE STATUS
- STATE PUMP
- VALVATED SOLENOID GAS STATE
- STATE DAMPERS RECIRCULATION
- BY-PASS DAMPER STATE



Viewing the display menus and information

CONTROL PANEL - DISPLAY AND ALARM RESET

From the main display by pressing the button **ALARM** it is possible to access the display of the alarms in progress; the alarm status can be:

- Active: if the cause of alarm is still present; in this case the alarm can not be reset
- Reset: the cause that generated the alarm is not present; the alarm can be reset.

To reset the alarms, press the RST ALL button (T7) for 2 seconds.

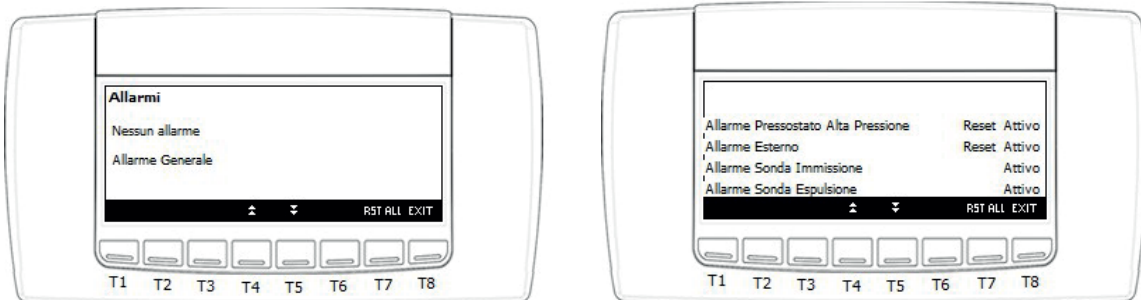

Alarm display and reset

CONTROL PANEL - FUNCTIONS MENU

Press the button **SERVICE** to access the SERVICE menu within which you can perform the following operations:

The entry in the function menu (press "menu" key) gives the possibility to:

- Access the unit configuration menu.
- Access the clock menu.
- Access the alarm menu in progress.
- Access the alarm history menu.
- Display the unit status by consulting the digital and analog inputs / outputs.
- Access the control panel menu.

The Exit button allows you to return to the previous menu level.

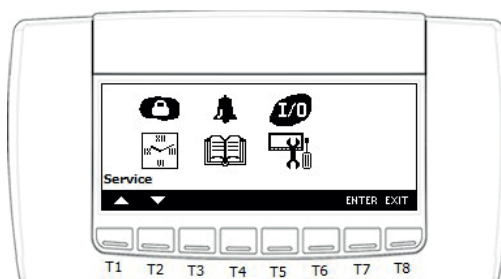

Display service menu



CONTROL PANEL - MENU CLOCK AND TIME BANDS



In the clock menu you can view all the parameters regarding date / time and time bands.

pressing the button  you can access the set date / time menu, where you can change the date and time.

Pressing the button  accesses the time bands menu where it is possible to set the automatic operation of the machine.

To activate the operation by means of time slots, the parameter Adjustment on time bands to SI must be set.

It is possible to set up to 3 different time bands (the band to work correctly must have a start time that is less than or equal to the stop value).

Once the time slots have been defined, the type of daily function must be assigned for each day of the week, as follows:

- 0= operation from time slots disabled
- 1= foperation with band n ° 1 enabled
- 2= operation with band n ° 2 enabled
- 3= operation with bands n ° 1 + 2 enabled
- 4 = operation with band 3 enabled
- 5 = operation with bands n ° 1 + 3 enabled
- 6 = operation with bands n ° 2 + 3 enabled
- 7 = operation with bands n ° 1 + 2 + 3 enabled

It is also possible to define the type of band between reduced and normal; if the band is reduced, the operation in that band only provides ventilation, with the exclusion of dehumidification and integration, if the band is normal, the operation will include all the available functions.

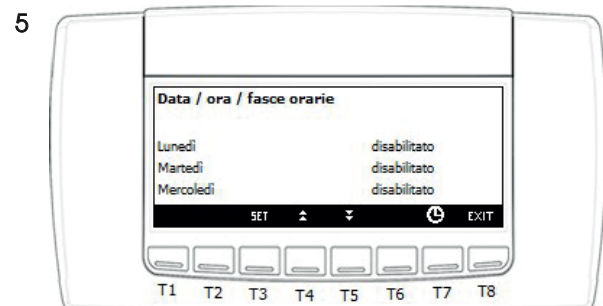
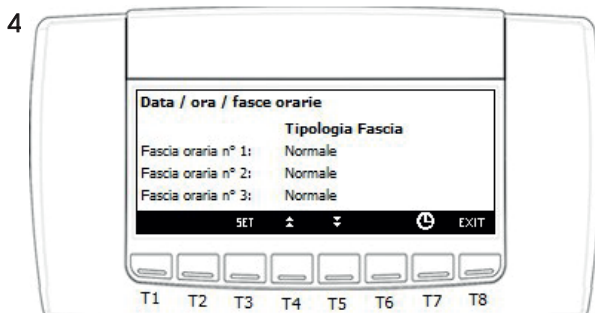
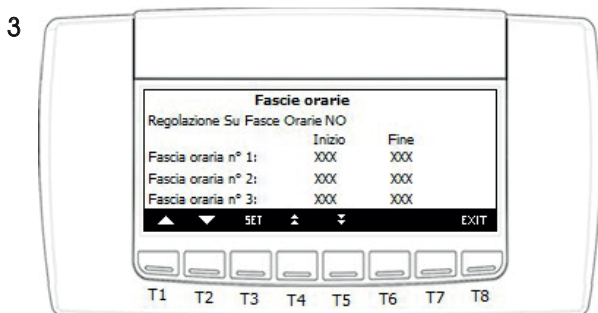
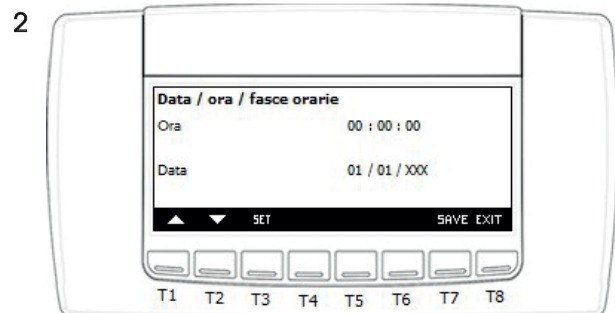
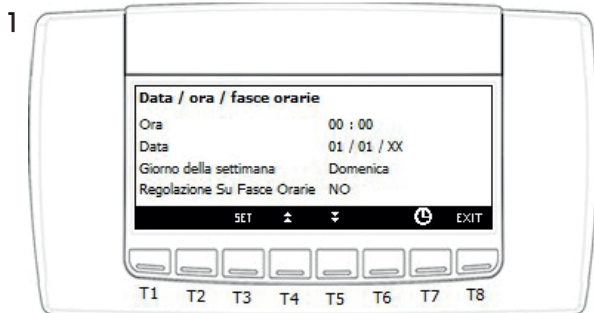

Display and adjustment of the clock menu



CONTROL PANEL - MENU ALARMS IN PROGRESS



From the main display, press the button **SERVICE** to access the display of the alarms in progress (bell); The Alarm status can be:
Active: if the cause of alarm is still present; in this case the alarm can not be reset
Reset: the cause that generated the alarm is not present; the alarm can be reset.

To reset the alarms, press the RST ALL button (T7) for 2 seconds.

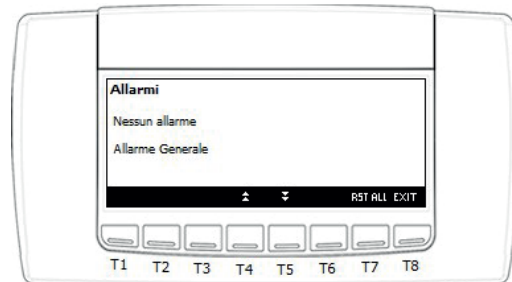

Menu display of alarms in progress

CONTROL PANEL - HISTORY MENU ALARMS



Using the **▲** or **▼** keys you can view all the stored alarms.
press the button **RST ALL** to execute the operation of deleting all the alarms recorded by the instrument

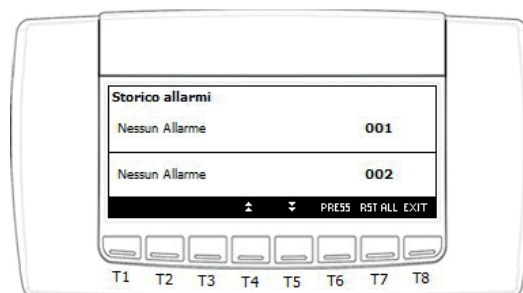

Alarm history menu display

CONTROL PANEL - MENU INPUTS / OUTPUTS



Use the **▲** or **▼** keys to select the quantities you wish to view, then press **ENTER** to access

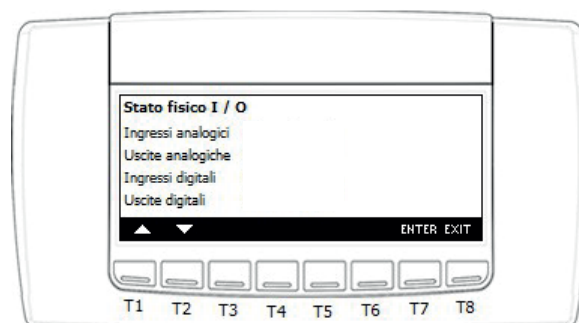

Menu display of inputs / outputs



Use the  or  keys to select the quantities you wish to view, then press  to access.

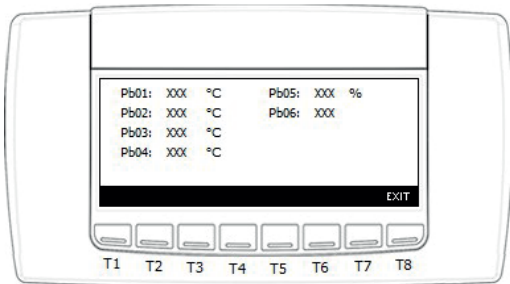

Display of values / status of analog inputs

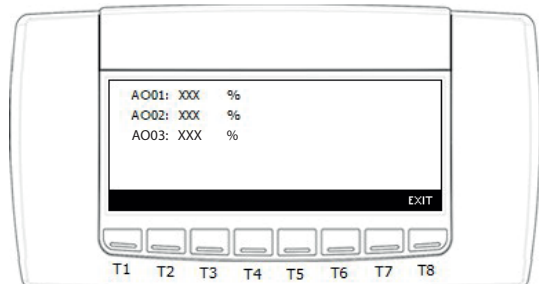

Display of the values / status of the analog outputs

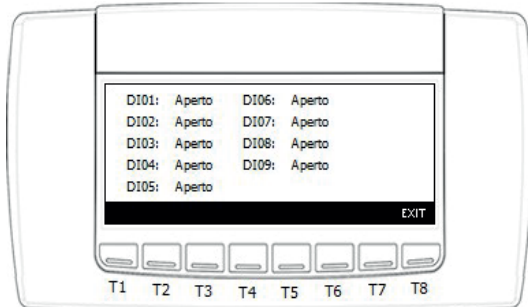

Display of the status of the digital inputs

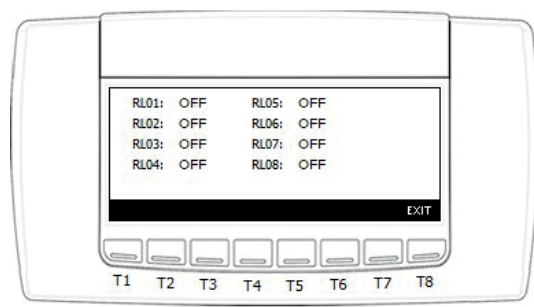

Display of the status of the relays







CONTROL PANEL - DISPLAY AND INFORMATION SETUP MENU



Through the control panel you can set:

1. display contrast
2. activation time
3. backlight
4. language selection
5. display information on the firmware and BIN versions of the IPRO and the keyboard.

Operations to perform to change a setting:

- use the keys   to select the setting to be changed
- Press the button 
- change the setting using the  or  keys
- confirm the operation by pressing the button 



Viewing the display menus and information



Use the  or  keys to select the quantities you wish to view, then press  to access.

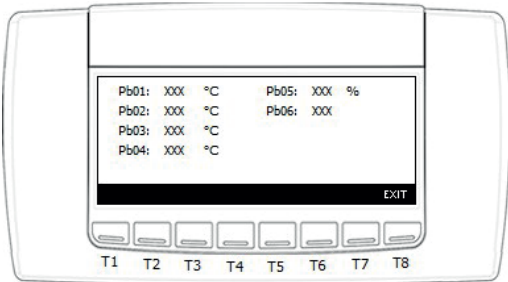

Display of values / status of analog inputs

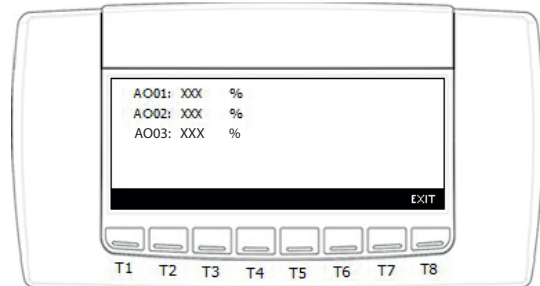

Display of the values / status of the analog outputs

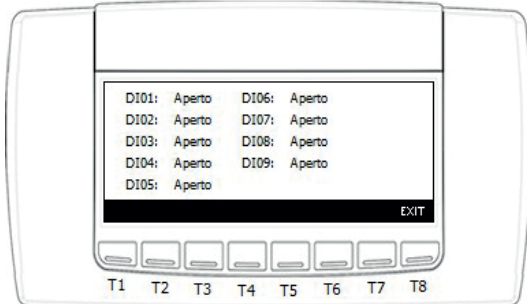

Display of the status of the digital inputs

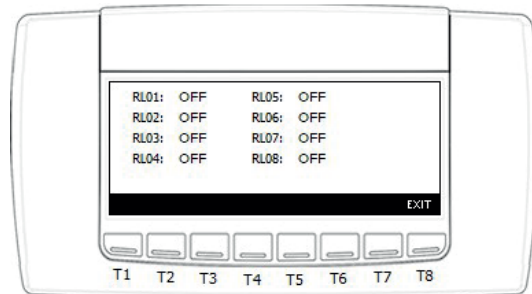

Display of the status of the relays







CONTROL PANEL - DISPLAY AND INFORMATION SETUP MENU



Through the control panel you can set:

1. display contrast
2. activation time
3. backlight
4. language selection
5. display information on the firmware and BIN versions of the IPRO and the keyboard.

Operations to perform to change a setting:

- use the keys   to select the setting to be changed
- Press the button 
- change the setting using the  or  keys
- confirm the operation by pressing the button 



Viewing the display menus and information



CONTROL PANEL - FACTORY MENU (PW:FACTORY=10)

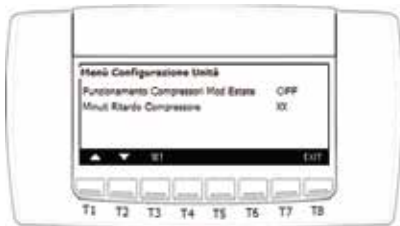

The parameters for correct machine operation must be set in the configuration menu. Summer mode compressor operation: Allows to include / exclude compressors in summer mode. Compressor delay minutes: inserts a compressor switch-on delay time.

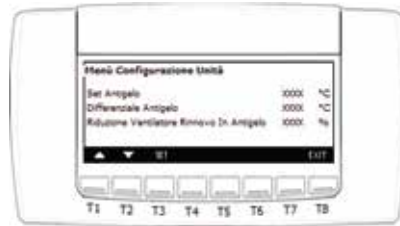

Antifreeze set: set indicating the antifreeze value; below this value the machine goes into antifreeze. Antifreeze differential: sets the value of the antifreeze differential: if the probe value is higher than the set + antifreeze differential, the machine exits the antifreeze state. Antifreeze Renewal Fan Reduction: indicates the speed reduction of the antifreeze renewal fan (percentage value).

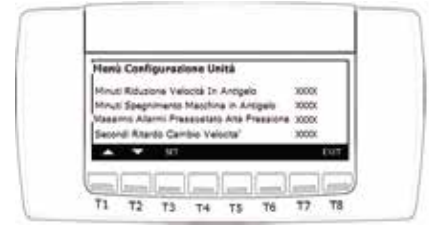

Minutes Anti-freeze speed reduction: indicates the time limit in which the fan speed will be reduced; if in this time the antifreeze condition does not re-enter the machine will go off antifreeze. Minutes Switch off Machine in antifreeze: machine stay time in OFF from antifreeze. Mass Alarms High Pressure Switch: indicates the maximum number of automatic restarts in an hour after the high pressure alarm. Seconds Speed change delay: Indicates the delay time in the speed change of the supply fan in the passage change of the supply fan at the passage goes dehumidification / integration ventilation

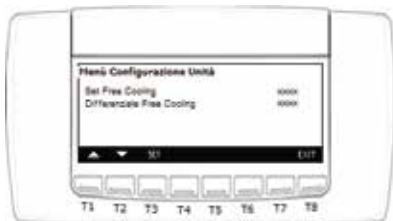

Set Free cooling: Indicates the differential values between the outdoor temperature and the recovery temperature to activate the free cooling mode by unbalancing the fans.

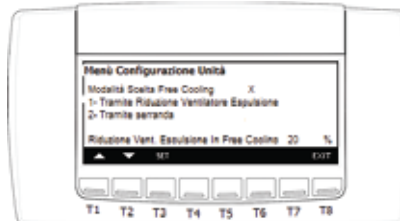

Choice mode Free cooling: Allows you to select the free cooling mode between the imbalance of the fans (the % can also be set) or via the damper



- External alarm action:
- Allows you to select the effect that a possible external alarm will have on the machine, a simple display or the block



SETTINGS MENU (PW: settings = 2)



Winter dehumidification consent: Allows to enable the dehumidification function during the winter season.

Dirty Filter Timer: Indicates the time limit required to generate the alarm of dirty filters (in tens of hours). If the alarm is not reset, the dehumidification function is inhibited.

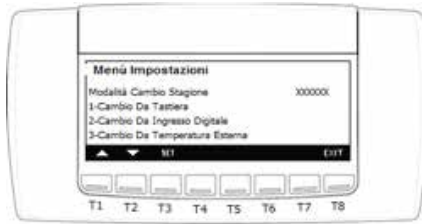

Change season mode: Defines the season change mode according to the methods indicated in the image

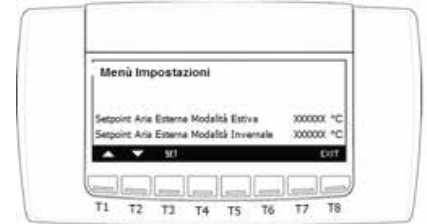

Summer Air SetPoint and Winter Air SetPoint: If the Season change mode is set to 3 it indicates the season change temperature limits.

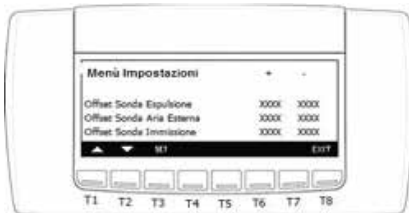

- Probe offset:
- allows to adjust the probe offset:
- under the column + there will be a positive correction of the value of the probes, while below the column - there will be a negative correction of the value of the probes.

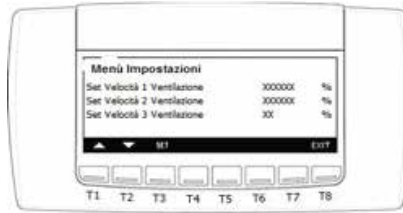

Ventilation Speed Set:
Indicates the values of the 3 speeds in ventilation mode of the supply fan. The values are in percentage and can vary between 0 and 100%



Expulsion Speed Set:
Indicates the values of the 3 speeds of the ejection fan. The values are in percentage and can vary between 0 and 100%

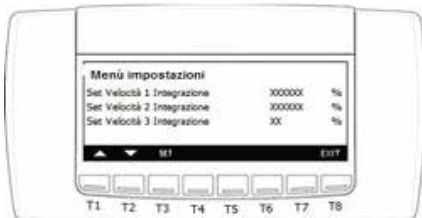

Integration Speed Set:
Indicates the 3 speed values in integration mode of the supply fan. The values are in percentage and can vary between 0 and 100%.



Hood Speed Set: Indicates the working percentage of the fan with a hood closed digital input. The value is in percentage and can vary between 0 and 100%. Bath Speed Set: Indicates the working percentage of the fan with the digital bathroom closed input. The value is in percentage and can vary between 0 and 100% Minute Hood Input Activation: Indicates the operation time of the hood digital input. Once the digital input is closed, the fan will operate according to the hood set for this time, then it will return to normal operation. Minutes Activation Bathroom input: Indicates the operating time of the bathroom digital input. Once the digital input is closed, the fan will operate according to the hood set for this time, then it will return to normal operation.

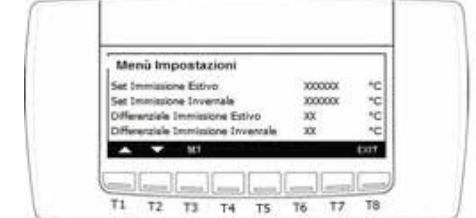

Summer / Winter Entry Set and related differentials:
Values used for the regulation of the 3-point / 0 -10V valve
The regulation follows the input probe

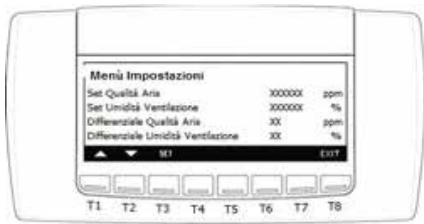

Air Quality / Humidity setting Ventilation: With Parameter choice ventilation mode other than 0, values used for fan adjustment. The adjustment follows the Air Quality or humidity probe according to the value of the parameter.



Ventilation Choice Mode: Indicates the regulation mode of the fans:
Manual: The fans operate at the set speed, 1, 2 or 3.
 - Air quality: The fans automatically change between V1 and V3 depending on the air quality set and the relative value read by the probe.
 - Humidity: The fans automatically change between V1 and V3 depending on the ventilation humidity sets and the relative value read by the probe.



Compressor Enable Set: Value that indicates an outdoor air temperature limit below which the compressor is not activated. **Stroke Time 3 Point Valve:** Select the running time of the connected valve. The value is expressed in seconds.



Mode Selection Adjustment: Defines the mode of choice for adjusting the machine according to the methods indicated in the image.



External damper presence: Allows the 0-10V command to be enabled for a damper on the outside air intake in order to reduce the contribution of fresh air during the dehumidification function.
Max external damper opening: Allows to set the maximum opening of the damper.
Max external damper closing: Allows to set the maximum closing of the damper.
Damper delay activation minutes: It allows you to set a delay time for the damper to be enabled.



Reduction of external damper opening: allows to set the reduction in percentage of opening. **Damper opening reduction time** allows you to set the time interval between each reduction.



ALARMS CONTROL ELECTRONIC CONTROL

Below is the table of operating anomalies of the unit

Display of the alarm condition

CODE	DESCRIPTION	CAUSE	REMEDY
	Obstructed filters (Signaling)	- Reporting time for filter changes	- Check the status of the filters
	Temperature probe alarm	- Breakage and failure to read the probe	- Replace the temperature probe
	High pressure alarm	- Press of the high pressure switch	- Check water circulation - Check air flow - Check air / water inlet temperatures - Check the status of the high pressure switch
	External alarm	- Digital input alarm	- Check the status of the external alarm signaling device
	Input temperature alarm water	- Very high or too low value of the water inlet temperature	- Check the regulation of the generator for the control of the water inlet temperature
No link	Communication alarm	- No display communication	- Check the connection between the display and the unit

GENERAL ANOMALIES TABLE

PROBLEM	CAUSE	REMEDY
Display off	No power supply (light switch off)	Check the connection to the mains Check and replace the existing fuse if necessary on the (black) power connector on the side of the unit.
Low or no air flow The rooms remain damp	Clogged filters	Replace the filters
	Clogged heat exchanger	Clean the exchanger
	Frozen heat exchanger	Bring the exchanger to a warm place and wait for it to thaw, do not heat with direct heat.
	Dirty fan	Clean the fan
	Clogged fan ducts	Clean the ventilation ducts
	Outdoor temperature lower than 0 ° C	The unit may be in antifreeze mode, wait until the outside temperature increases or provide for the installation of an electric pre-heating.
High noise level	Noise from the unit	Check for cracks and / or air leaks from panels of the unit Check the siphon connection Check if the motors turn correctly (bearings)
	Noise coming from the ducts	Check for cracks on the suction / inlet / exhaust ducts
High vibrations	Panels that vibrate	Check the integrity of the aluminum panels/profiles of the unit Check that the cover of the unit and the panel covering the electronic card are closed correctly Check that there are no walls that can transmit vibrations to the wall / floor / countertops
	Unbalanced fans blades	Check the integrity of the blades Clean the fans Check that the fans are still present small metal clips for balancing the blades themselves
Condensation loss	Clogged condensate drain	Clean the condensate drain
	The condensate does not flow from the exhaust pipe into the collection tray	Verify that the unit is perfectly flat Check that the condensate drain connections are clogged



MODBUS VARIABLES

baud rate=9600 / data length=8 bit / parity = none \ even \ odd / bit stop = 1

TYPE	NAME	Hexadecimal address	Reading	Writing	NOTE
PHYSICAL STATE INPUTS AND OUTPUTS					
DINT	Analog Input AI01	F000		R	entering temperature
DINT	Analog Input AI02	F001		R	extraction temperature
DINT	Analog Input AI03	F002		R	expulsion temperature
DINT	Analog Input AI04	F003		R	external temperature
DINT	Analog Input AI05	F004		R	humidity
DINT	Analog Input AI06	F005		R	ppm air quality probe
DINT	Analog Output AO01	F020		R	fan set renewal
DINT	Analog Output AO02	F021		R	extraction fan set
DINT	Analog Output AO03	F022		R	0-10V valve set
DINT	Analog Output AO04	F023		R	/
BOOL	Digital Input DI01	F050		R	high pressure input status
BOOL	Digital Input DI02	F051		R	external alarm input status
BOOL	Digital Input DI03	F052		R	integration input status
BOOL	Digital Input DI04	F053		R	dehumidification input status
BOOL	Digital Input DI05	F054		R	remote on-off input status
BOOL	Digital Input DI06	F055		R	summer-winter entry status
BOOL	Digital Input DI07	F056		R	only ventilation input status
BOOL	Digital Input DI08	F057		R	hood input status
BOOL	Digital Output Relay RL01	F080		R	recirculation damper outlet status
BOOL	Digital Output Relay RL02	F081		R	valve output status open
BOOL	Digital Output Relay RL03	F082		R	valve outlet status closed
BOOL	Digital Output Relay RL04	F083		R	/
BOOL	Digital Output Relay RL05	F084		R	pump output status
BOOL	Digital Output Relay RL06	F085		R	compressor output status
BOOL	Digital Output Relay RL07	F086		R	external alarm output status
BOOL	Digital Output Relay RL08	F087		R	by-pass output status
SETPOINT					
DINT	Summer Adjustment Set	2048		R/W	Value in tenths (ie 200 corresponds to 20 ° C)
DINT	Winter Adjustment Set	2054		R/W	Value in tenths (ie 200 corresponds to 20 ° C)
DINT	Differential Summer Adjustment	2023		R/W	Value in tenths (ie 200 corresponds to 20 ° C)
DINT	Differential Winter Adjustment	2023		R/W	Value in tenths (ie 200 corresponds to 20 ° C)
DINT	Summer humidity set	2049		R/W	
DINT	Winter humidity set	2055		R/W	
DINT	Summer humidity differential	2024		R/W	
DINT	Winter moisture differential	2024		R/W	
DINT	Set. Renewal speed	2045		R/W	Value from 1 to 3
DINT	Set. Ejection speed	2043		R/W	Value from 1 to 3
DINT	Set. Speed renewal in deu / int	2046		R/W	Value from 1 to 3
PROBE					
DINT	External air probe	4500		R	Value in tenths (ie 200 corresponds to 20 ° C)
DINT	Expulsion probe	2003		R	Value in tenths (ie 200 corresponds to 20 ° C)
DINT	Input probe	2001		R	Value in tenths (ie 200 corresponds to 20 ° C)
DINT	Ambient recovery humidity probe	2006		R	
DINT	Air quality probe	2002		R	
DINT	Ambient temperature recovery probe	2000		R	Value in tenths (ie 200 corresponds to 20 ° C)
FASCE ORARIE					
DINT	DayWeek	4000		R	
DINT	Now	4005		R	
DINT	Minutes	4003		R	
DINT	Month	4004		R	
DINT	Year	4001		R	
DINT	Sunday active bands	4002		R	
DINT	Thursday active bands	AAAD		R/W	
DINT	Active bands Monday	AAAA		R/W	
DINT	Active bands Tuesday	AAA7		R/W	
DINT	Active bands Wednesday	AAA8		R/W	
DINT	Active bands Saturday	AAA9		R/W	
DINT	Friday active bands	AAA7C		R/W	
DINT	Now start band1	AAAB		R/W	
DINT	Now start band 2	AAA0		R/W	
DINT	Now start band 3	AAA1		R/W	
DINT	Now start band1	AAA2		R/W	
DINT	Now start band 2	AAA3		R/W	
DINT	Now start band 3	AAA4		R/W	
DINT	On / Off adjustment on time bands	AAA5		R/W	
BOOL	Band Type 1	AAA6		R/W	
DINT	Type of band 2	3654		R/W	
DINT	Type of band 3	3658		R/W	
DINT		3655		R/W	
OTHER VARIABLES					
BOOL	general allarm	2027		R/W	0=winter 1=summer
BOOL	On/Off	2013		R	0 = not in alarm 1 = in alarm
BOOL		2035		R/W	0 = off 1 = on

CLA & UTEK si riserva di apportare in qualsiasi momento le modifiche necessarie per migliorare i prodotti, senza obbligo di preavviso.
CLA & UTEK reserves the right to at any time the necessary changes to improve products without prior notice .

Gentile Cliente

Grazie per l'attenzione al prodotto UTEK, progettato e realizzato per garantire all'Utilizzatore valori reali: Qualità, Sicurezza e Risparmio sui consumi.

Dear Customer

Thanks for your attention to the product UTEK , designed and manufactured to ensure the real values to the User : Quality, Safety and Savings on working.



Made in Italy